

PARTICULATE FILTER/REGULATOR

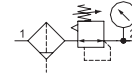

- High flow with a wide range of adjustable output pressure ranges
- Optional low profile gauge, round gauge, digital gauge or digital pressure switch
- Optional extended temperature range of -40 °F to 176 °F (-40 °C to 80 °C)
- Sintered polyethylene elements, with centrifugal separator, include 5, 25 and 40 Microns
- Threaded ports allow for individual or modular mounting
- Innovative two position plastic drain with manual and semi-automatic functions. Additional drains include an automatic style (brass) and manual (stainless steel)
- Polycarbonate and Aluminum bowls with a selection of sight gauge materials that meet industry and application requirements
- Key lockable and tamper resistant models
- Air purity class according to ISO 8573-1: 2010

Performance Data						
Series			651	652	653	
Port Sizes			1/8, 1/4	1/4, 3/8, 1/2	1/2, 3/4, 1	
Thread Type			NPTF, G & Rc			
Nominal Flow - Per ISO 6358 P1 = 145 PSI (10 bar) Setpoint P2 = 91.4 PSI (6.3 bar) ΔP = 14.5 PSI (1 bar)	1/8	Micron Rating	SCFM (L/min ANR)			
		5μ	25.1 (710)	-	-	
		25μ	25.8 (730)	-	-	
	1/4	40μ	28.5 (800)	-	-	
		5μ	79.1 (2240)	133.0 (3800)	-	
		25μ	83.4 (2360)	144.2 (4120)	-	
	3/8	40μ	100.1 (2840)	150.5 (4300)	-	
		5μ	-	155.8 (4450)	-	
		25μ	-	189.7 (5420)	-	
	1/2	40μ	-	196.0 (5590)	-	
		5μ	-	157.2 (4490)	275.4 (7800)	
		25μ	-	192.5 (5500)	278.9 (7900)	
	3/4	40μ	-	203.0 (5800)	307.2 (8700)	
		5μ	-	-	314.3 (8900)	
		25μ	-	-	317.1 (9000)	
	1	40μ	-	-	353.1 (10000)	
		5μ	-	-	317.8 (9000)	
		25μ	-	-	353.1 (10000)	
	Maximum Inlet Pressure PSIG (bar) P1	Polycarbonate Bowl		232 (16)		174 (12)
		Aluminum Bowl		232 (16)		290 (20)
Adjustable Pressure Ranges PSIG (bar) P2			3 to 45 (0.2 to 3)			
			3 to 60 (0.2 to 4)			
			7 to 125 (0.5 to 8)			
			7 to 145 (0.5 to 10)			
			-	-	7 to 232 (0.5 to 16)*	
Ambient Temperature Range °F (°C)			-4 to 122 (-20 to 50)			
Fluid Temperature Range °F (°C)			-4 to 122 (-20 to 50)			
Fluid			Air or Inert Gas			
Weight lbs. (kg)	w/Polycarbonate Bowl	0.62 (0.304)	1.20 (0.546)	2.90 (1.315)		
	w/Aluminum Bowl	0.99 (0.449)	1.52 (0.688)	3.45 (1.565)/3.90 (1.769)*		

* High pressure assisted version

Materials in Contact with Fluid		Air Purity Class - ISO 8573-1: 2010	
Body	Aluminum	5μ	(5:8:4)
Seals	NBR/FKM	25μ	(6:8:4)
Springs	Stainless Steel	40μ	(7:8:4)
Filter Element	Sintered Polyethylene		
Bowl	Polycarbonate or Aluminum		
Poppet	Brass		
Stem	PA		

How to Order - Particulate Filter/Regulator

8 **651** **A** **P** **B** **P** **2** **F** **A00** **G** **N**

Port Type
 8 = NPTF
 G = ISO 228/1-G
 J = ISO 7/1 Rc

Product Series
 651
 652
 653

Revision
 A

Product Type
 K = Filter/Regulator - Particulate with Internal Flow Check (652 only)
 P = Filter/Regulator - Particulate

Elements
 A = 40 Micron (Green)
 B = 5 Micron (White)
 J = 25 Micron (Yellow)

Bowl Type
 K = Metal Bowl without Sight Gauge
 L = Metal Bowl with Sight Gauge (Glass)
 M = Metal Bowl with Sight Gauge (Polyamide)
 N = Polycarbonate Bowl without Bowl Guard (651 only)
 P = Polycarbonate Bowl with Bowl Guard

Port Size
 1 = 1/8 (651 Series)
 2 = 1/4 (651 or 652 Series)
 3 = 3/8 (652 Series)
 4 = 1/2 (652 or 653 Series)
 5 = 3/4 (653 Series)
 6 = 1 (653 Series)

Gauge Type
 B = Digital Pressure Switch - PNP
 C = Digital Pressure Switch - NPN
 D = Digital Gauge
 F = Low Profile Gauge PSI/bar
 G = Low Profile Gauge bar/PSI
 H = Low Profile Gauge PSI/bar with Pressure Range Indicator
 J = Low Profile Gauge bar/PSI with Pressure Range Indicator
 N = No Gauge with Port Plate (1/8 NPTF)
 P = No Gauge with Port Plate (1/8 ISO 7/1 Rc)
 Q = Round Gauge bar/PSI
 R = Round Gauge PSI/bar
 0 = No Gauge Port

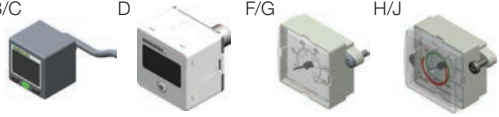
B/C **D** **F/G** **H/J**

N/P **Q/R** **0**

Drain Type
 0 = No Drain
 A = Auto Drain Normally Open
 N = Manual - Semi-automatic Drain
 Q = Manual Drain - Stainless Steel



Pressure Range
 D = 3-45 PSIG/0.2-3 bar
 E = 3-60 PSIG/0.2-4 bar
 G = 7-125 PSIG/0.5-8 bar
 H = 7-145 PSIG/0.5-10 bar
 N = 7-232 PSIG/0.5-16 bar (653 only)

Options
 A00 = No Options
 101 = Side Mounting Brackets
 102 = Panel Nut (651 and 652 only)
 103 = Tamper Resistant
 104 = Key Lockable
 105 = High Temperature (80 °C/176 °F)
 106 = Low Temperature (-40 °C/-40 °F)
 109 = FKM Seals
 113 = Stainless Steel Fasteners (652 and 653 only)
 114 = Provision for Key Lockable Option
 117 = ATEX Zones 1-21 
 119 = Panel Bracket with Panel Nut (651 and 652 only)
 121 = Non-relieving
 123 = Gauge Type Mounted for Right-to-Left Flow
 202 = 105 + 109
 2A9 = 105 + 106



- Conforms to ISO standards 1179-1
- Metal Bowl Types K, L, or M only
- If multiple options are required, please use the online CAD configurator on the website to generate the part number (www.asco.com), or consult factory
- Compressed air must be dry enough so no ice formation is present on the product. All bowls should be emptied prior to ambient temperatures dropping below 32 °F (0 °C)

Dimensions: mm (inches) 651/652/653 Series Particulate Filter/Regulator

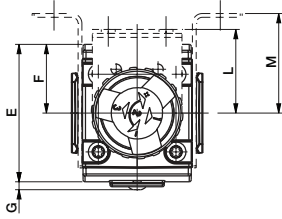

651/652 Series

653 Series

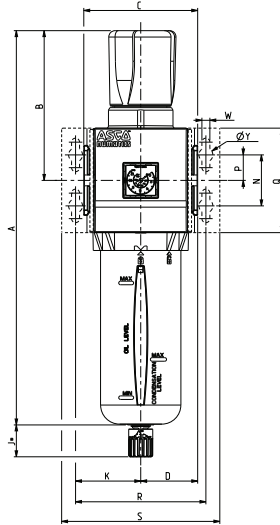
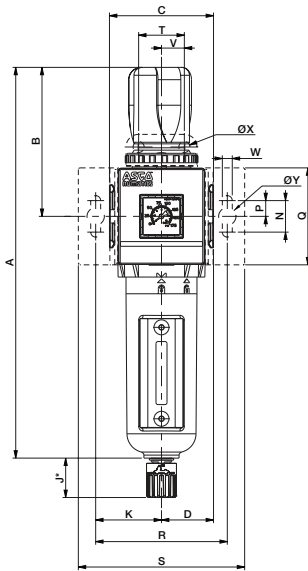

653 Series High Pressure
232 PSIG (16 bar)

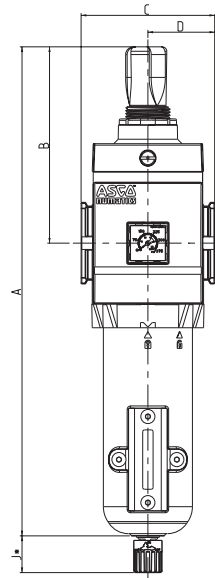

	A	B	C	D	E
653 High Pressure	329.5	132	90	45	93.6
	(12.97)	(6.20)	(3.54)	(1.77)	(3.69)

	F	G	H	J*
653 High Pressure	46.2	2.7	158.9	25
	(1.84)	(0.11)	(6.26)	(0.98)

	A	B	C	D	E	F	G	H	J*	K	L	M
651	215.5	77.5	50	25	58	29	3.4	116	25	35	42	44.5
	(8.48)	(3.05)	(1.97)	(0.98)	(2.28)	(1.14)	(0.13)	(4.57)	(0.98)	(1.38)	(1.65)	(1.75)
652	248	94.5	66	33	69	30.5	4	135	25	41.75	42	50
	(9.76)	(3.72)	(2.60)	(1.30)	(2.72)	(1.20)	(0.16)	(5.31)	(0.98)	(1.64)	(1.65)	(1.97)
653	315.2	117.5	90	45	93.6	46.8	2.7	155.4	25	52	-	62
	(12.41)	(4.63)	(3.54)	(1.77)	(3.69)	(1.84)	(0.11)	(6.12)	(0.98)	(2.05)	-	(2.44)

	N	P	Q	R	S	T	V	W	ØX	ØY	ZB
651	20	10	50	70	92	29	14.5	6.3	7	11	M30 x 2
	(0.79)	(0.39)	(1.97)	(2.76)	(3.62)	(1.14)	(0.57)	(0.25)	(0.28)	(0.43)	
652	20	10	61.5	84	105.5	29	14.5	6.3	7	11	M37 x 2
	(0.79)	(0.39)	(2.42)	(3.31)	(4.15)	(1.14)	(0.57)	(0.25)	(0.28)	(0.43)	
653	40	20	82	104	126	-	-	6.3	-	11	-
	(1.57)	(0.79)	(3.23)	(4.09)	(4.96)	-	-	(0.25)	-	(0.43)	

* Variable dimension based on type of drain that is specified; if an Automatic Drain is specified, add another 5mm to J dimension.

Cross Section -
651/652/653 Series
Particulate Filter/
Regulator

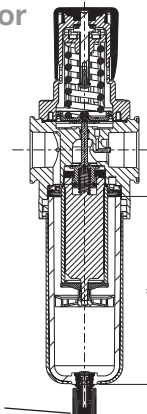

To remove bowl allow:
651 - 44mm (1.8in)
652 - 75mm (3.0in)
653 - 100mm (4.0in)
from the bottom of the bowl drain

Particulate Filter/Regulator Flow Charts

